

0200

▲ **Pudła klapowe** są to pudełka złożone zasadniczo z jednej części, których brzeg jest klejony, szyty, albo które mają połączenie taśmą klejącą oraz posiadają górne i dolne kłapy. Producent wysyła je złożone na płask, gotowe do użycia, a zamyka przy zastosowaniu kłapy.

▲ **Slotted-type boxes** consist of basically one piece with a glued, stitched or taped manufacturers joint and top and bottom flaps. They are shipped flat, ready to use and require closing using the flaps provided.

0200

M/A

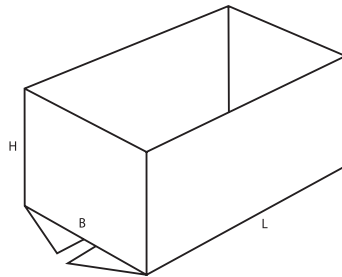
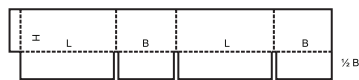

0201

M/A

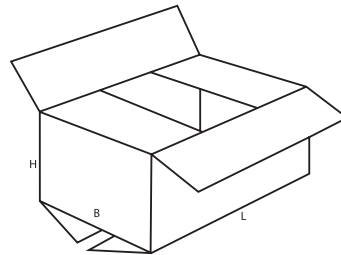
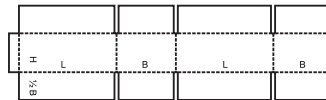

0202

M/A

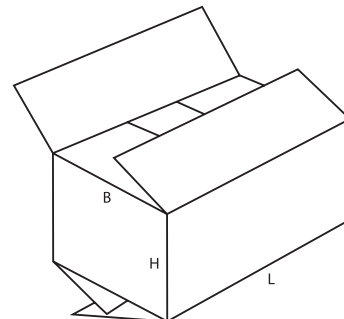
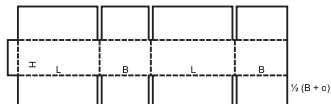

0203

M/A

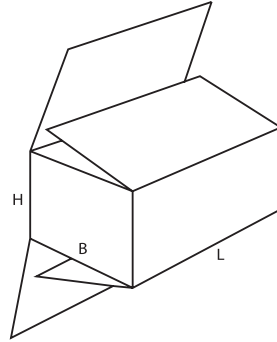
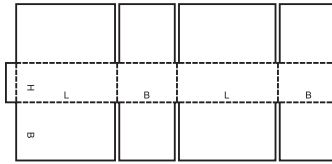

0204

M/A

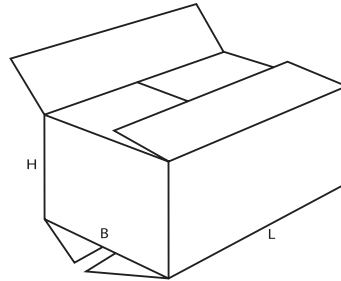
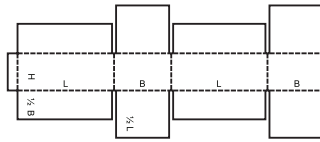

0205

M/A

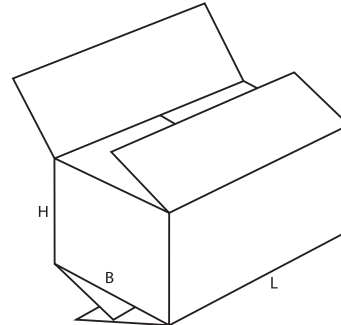
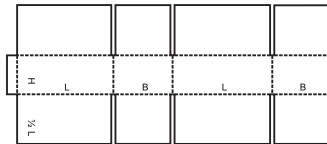

0206

M/A

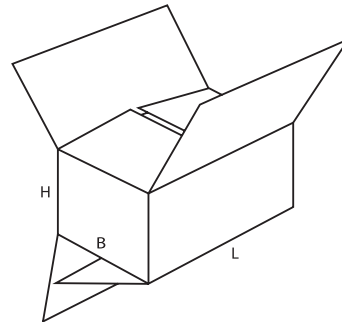
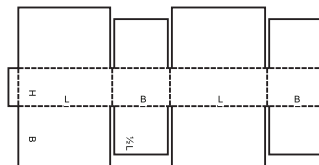

0207 M

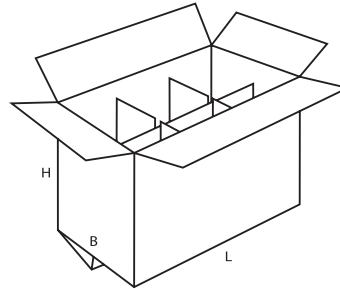
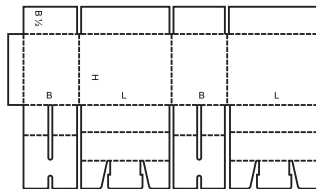

0208 M

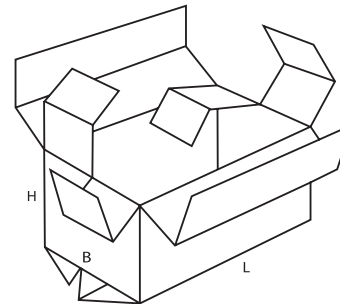
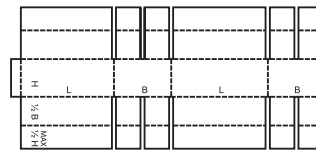

0209 M/A

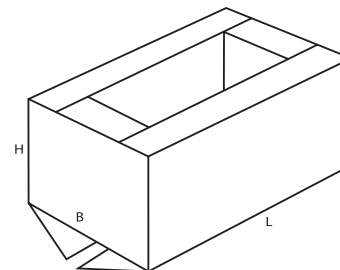
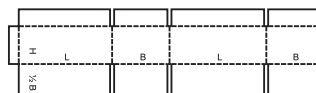

0210 M

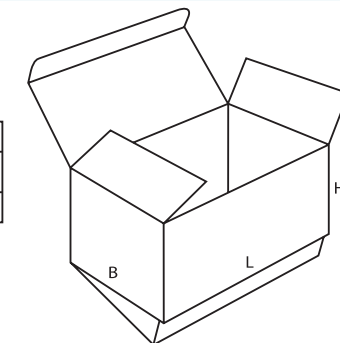
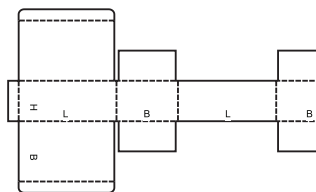

0211 M

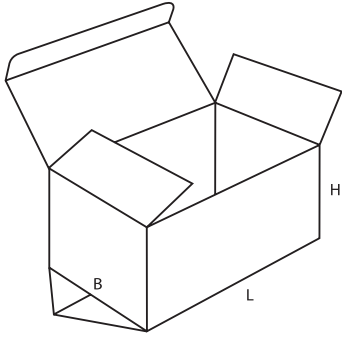
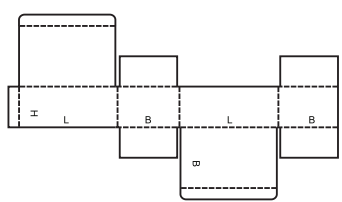

0212 M/A

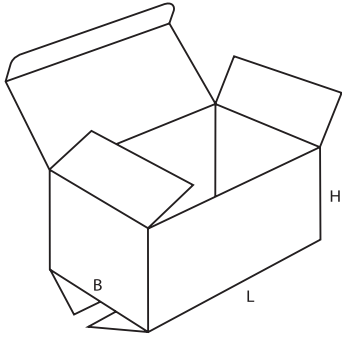
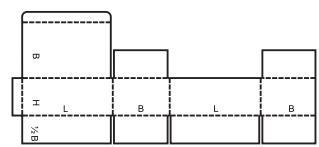

0214 M

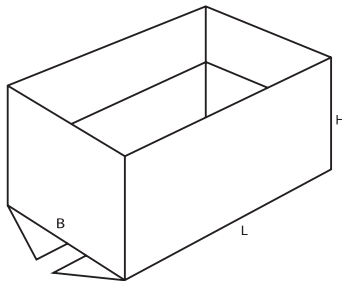
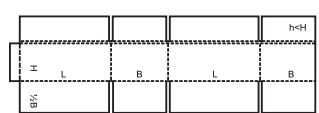

0215 M

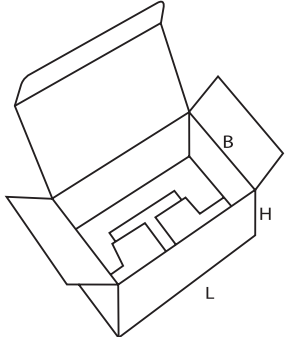
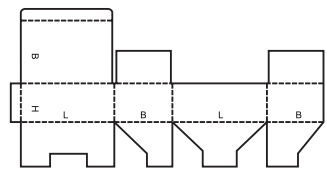

0216 M

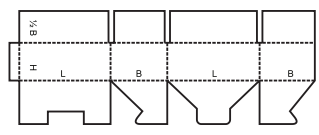

closure of top can be automated

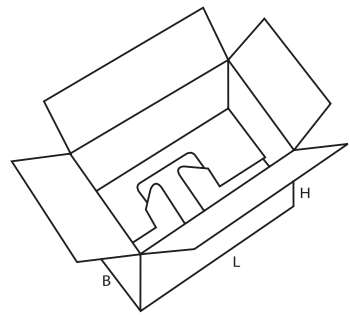

0217 M

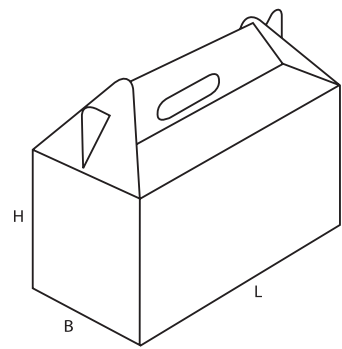
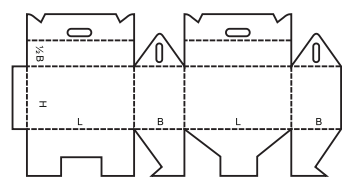

0218 M

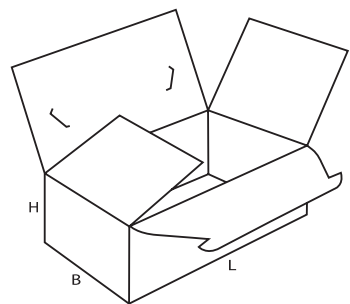
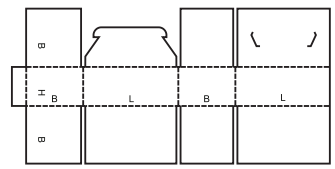

0225 M

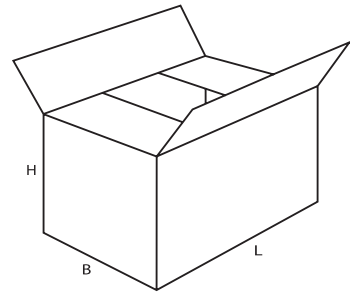
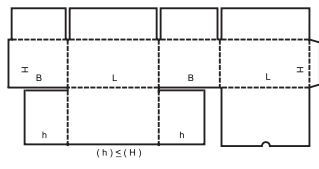

0226

M

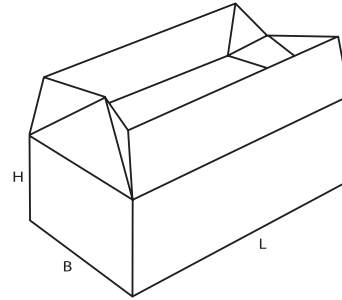
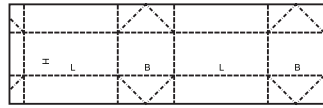

0227

M

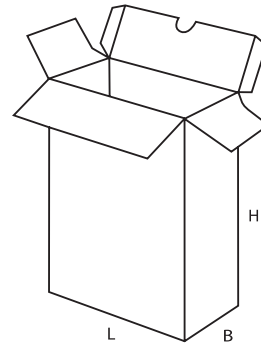
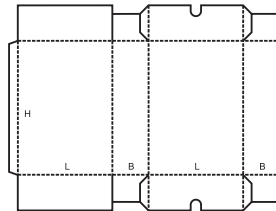

0228

M/A

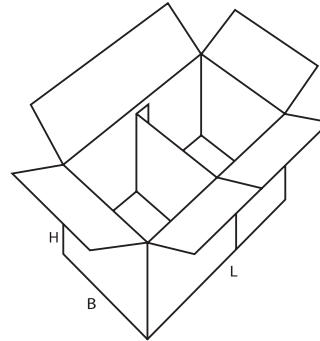
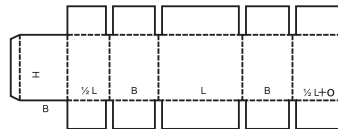

0229

M

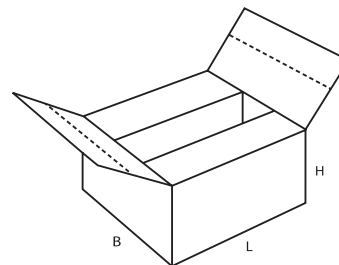
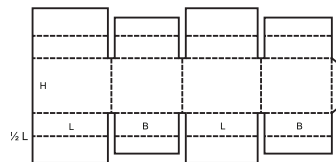

0230

M/A

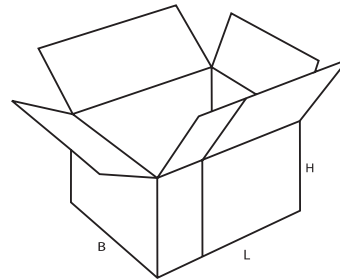
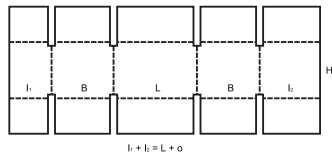

0231

M/A

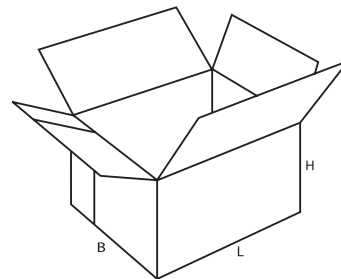
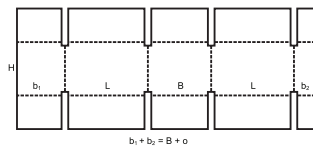

0300

▲ **Pudła teleskopowe** składają się z więcej niż jednej części i charakteryzuje je istnienie wieka i/lub spodu, które zachodzą teleskopowo na siebie.

▲ **Telescope-type** boxes consist of more than one piece and are characterised by a lid and/or bottom telescoping over the body of the box.

0300 M/A

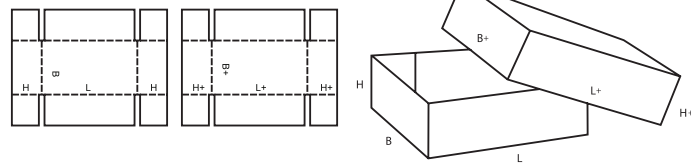

0301 M/A

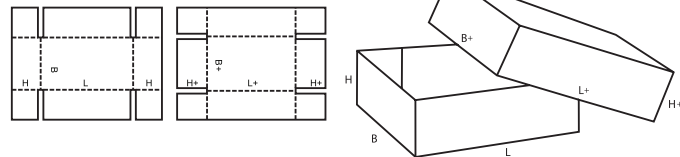

0302 M

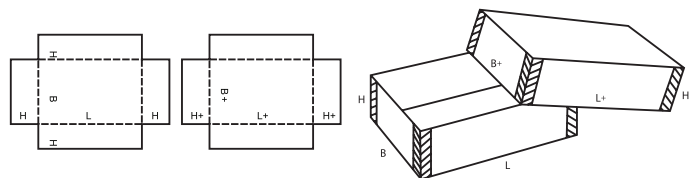

0303 M

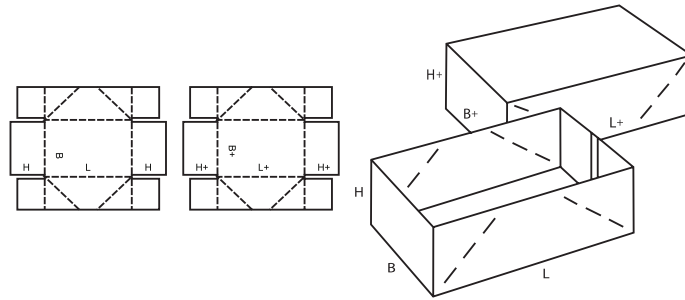

0304 M

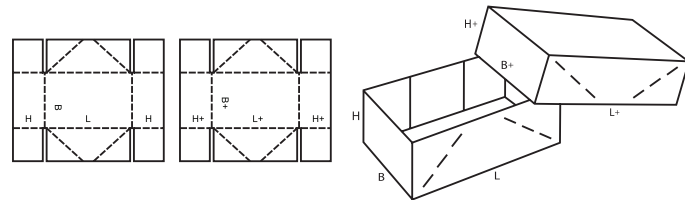

0306 M/A

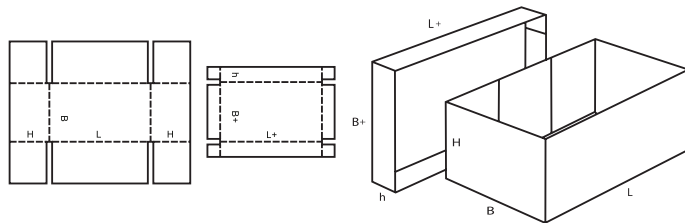

0307 M

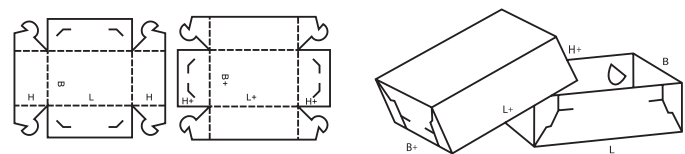

0308 M

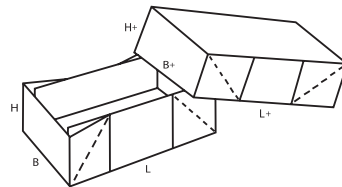
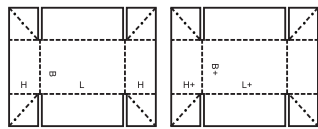

0309 M

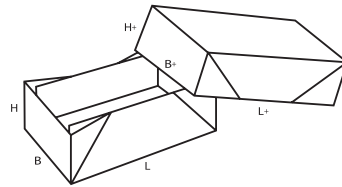
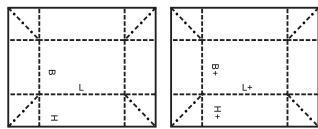

0310 M+A

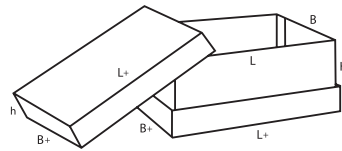
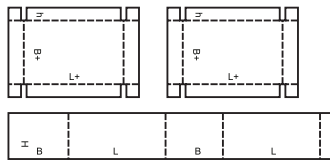

0312 M/A

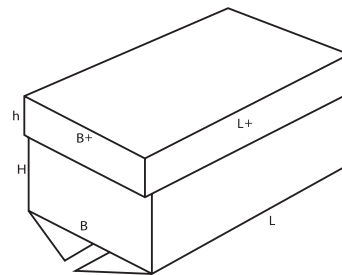
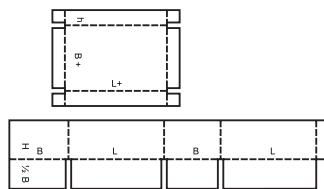

0313 M/A

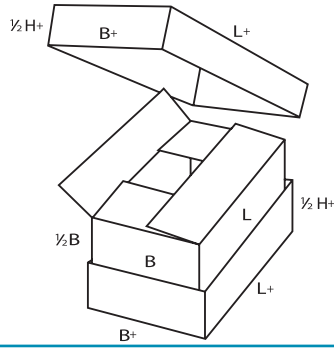
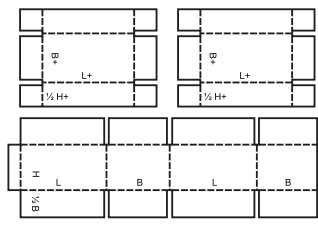

0314 M

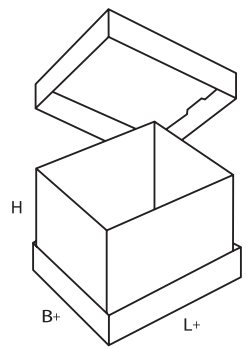
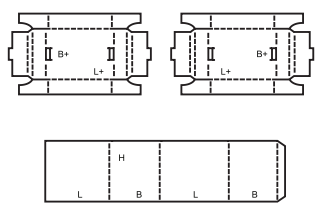

0320 M/A

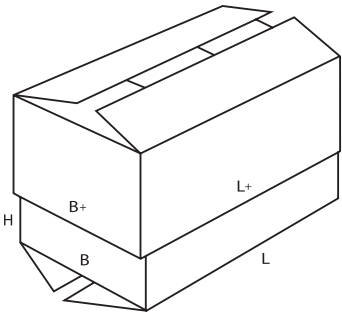
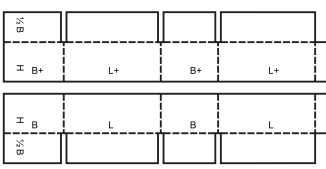

0321 M

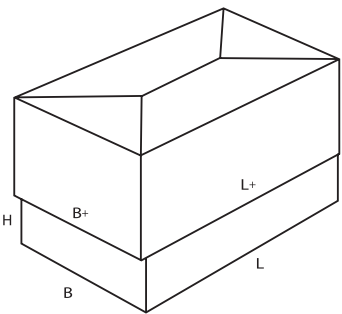
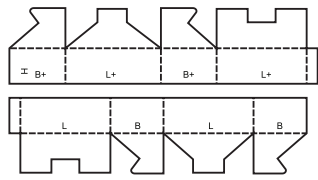

0322 M

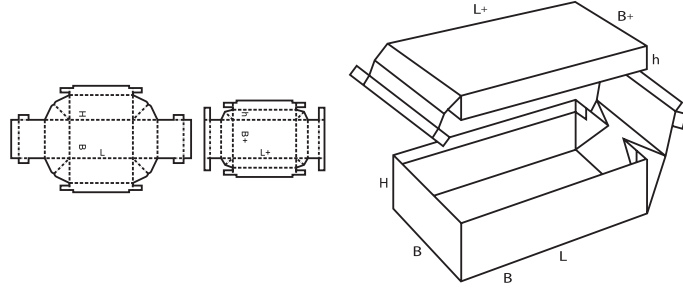

0323 M

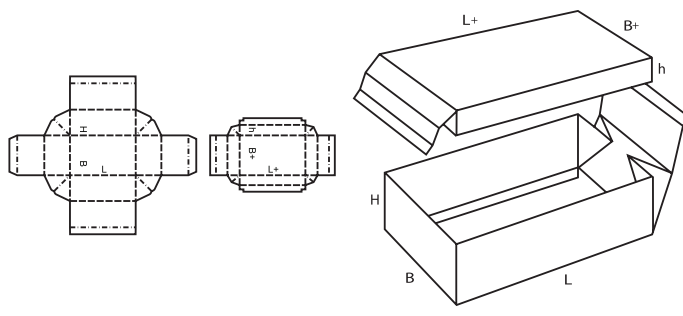

0325 A

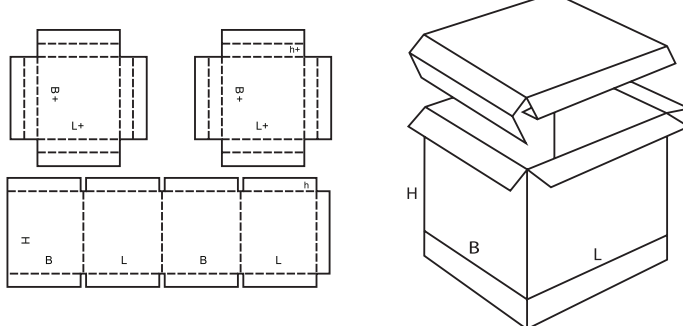

0330 M/A

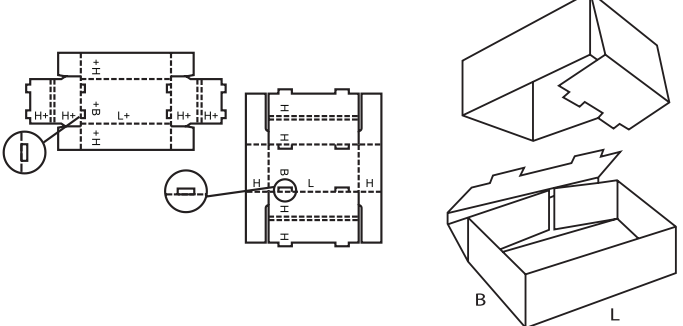

0331 M/A

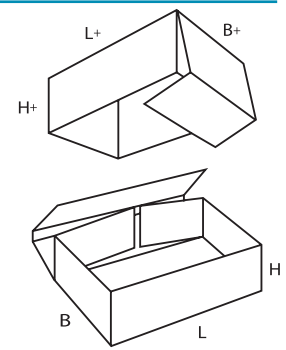
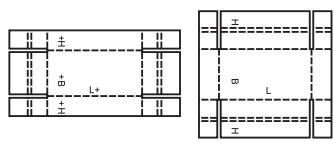

0350 M

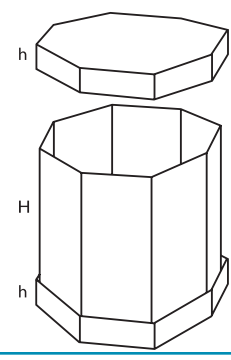
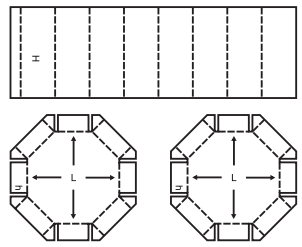

0351 M/A

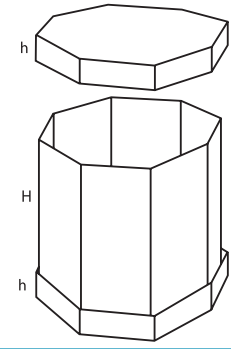
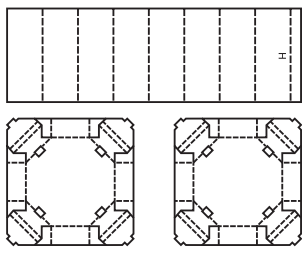

0352 M/A

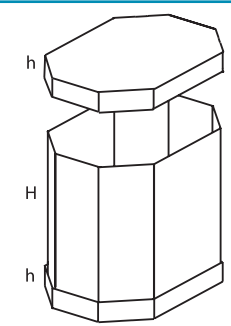
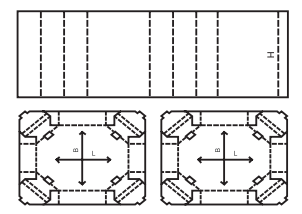

0400

▲ **Pudła składane i tace** zwykle składają się tylko z jednego formatu. Dno pudła składa się tak, by utworzyć dwie lub więcej ścian bocznych oraz pokrywę. W niektórych wzorach mogą się pojawiać zamknięcia, uchwyty, okienka itd.

▲ **Folder-type boxes** and trays usually consist of only one piece of board. The bottom of the box is hinged to form two or all side walls and the cover. Locking tabs, handles, display panels etc., can be incorporated in some designs.

0400

M

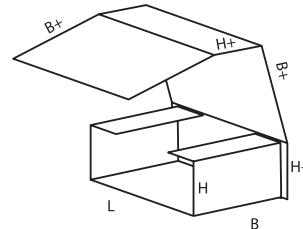
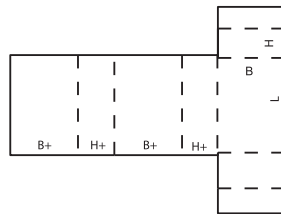

0401

M

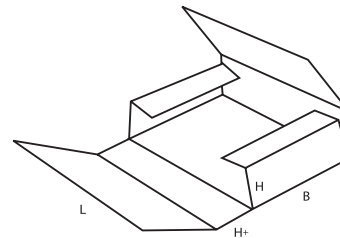
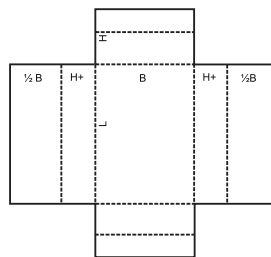

0402

M

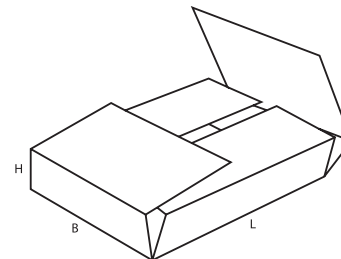
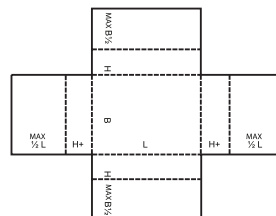

0403

M

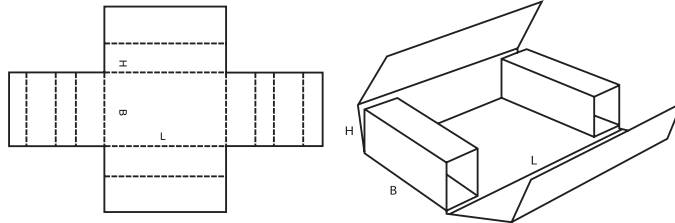

0404

M

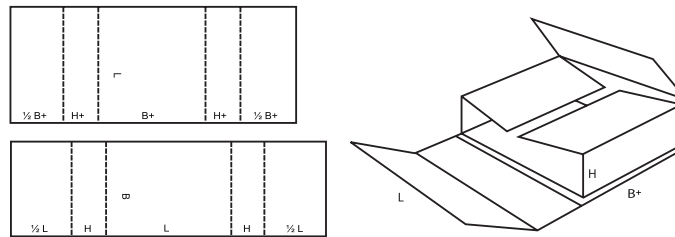

0405

M

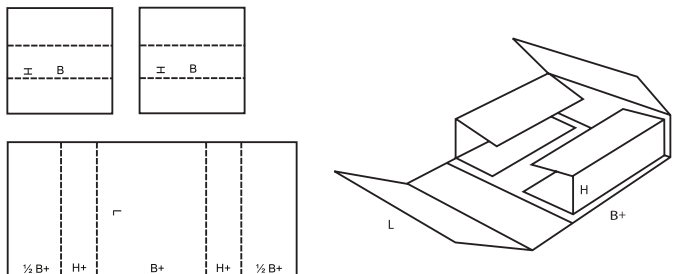

0406

A

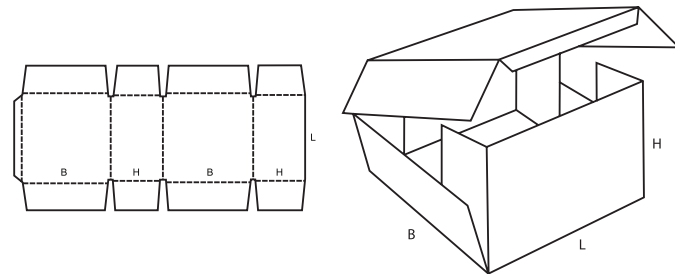

0409

M

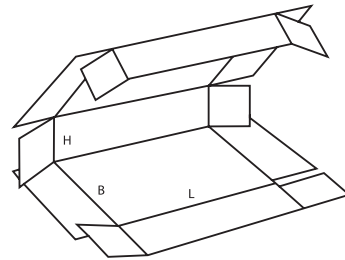
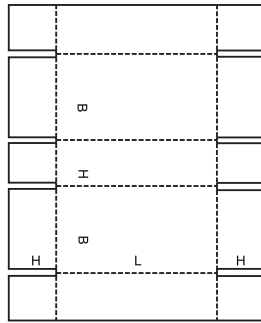

0410

M/A

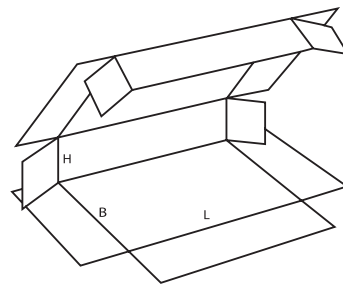
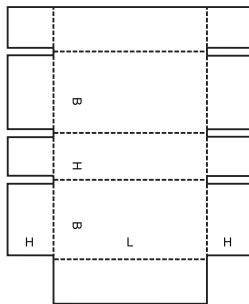

0411

M/A

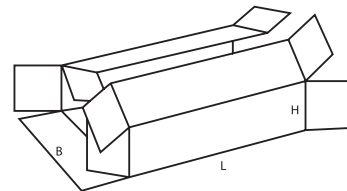
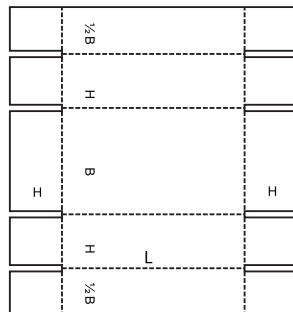

0412

M

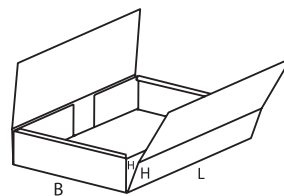
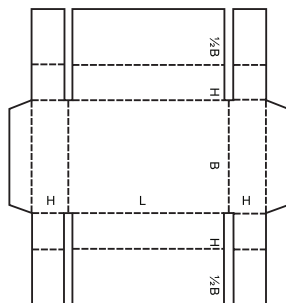

0413 M/A

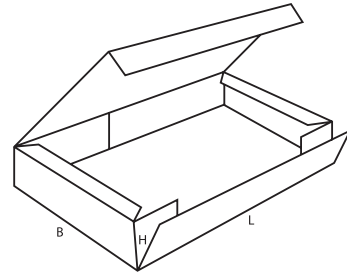
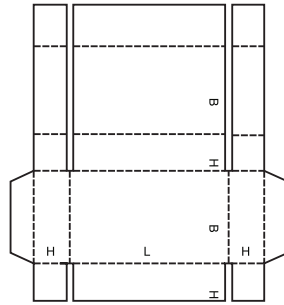

0415 M/A

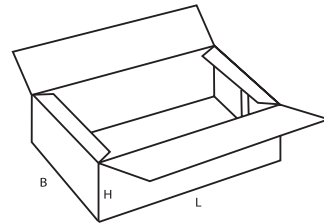
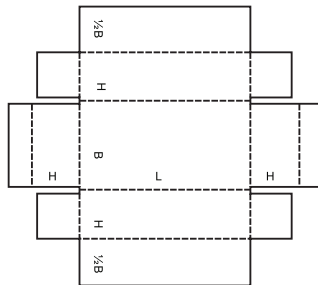

0416 M

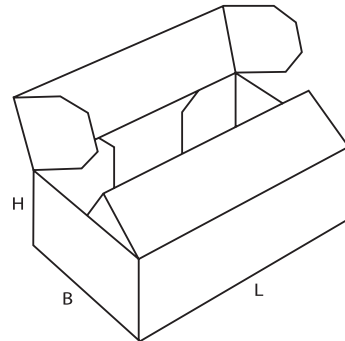
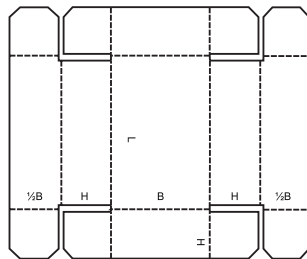

0420 M/A

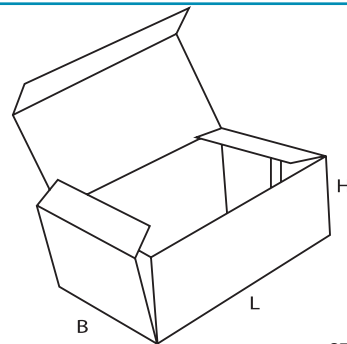
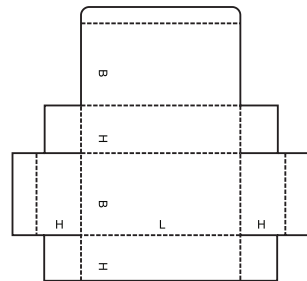

0421 M/A

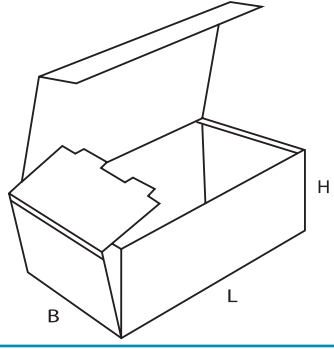
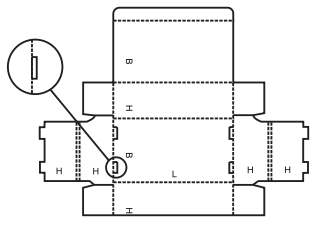

0422 M/A

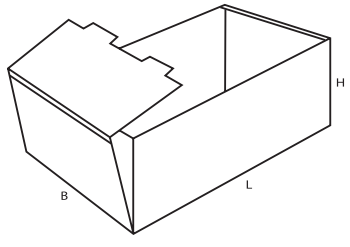
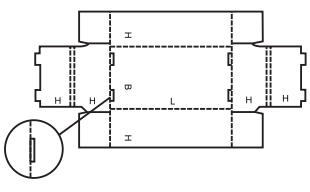

0423 M/A

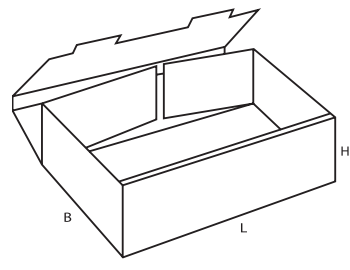
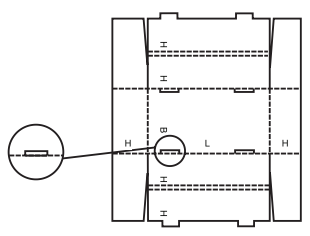

0424 M/A

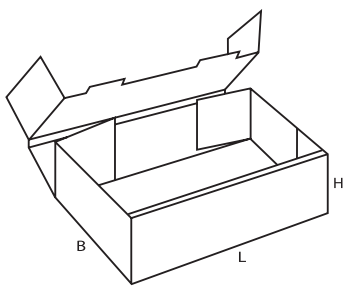
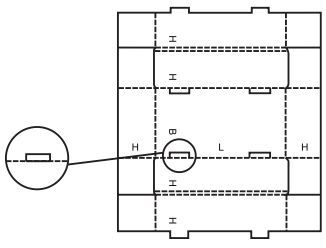

0425

M/A

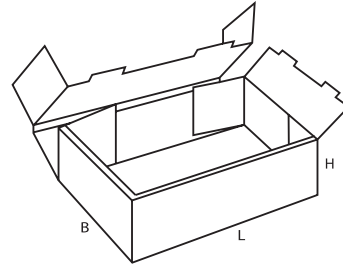
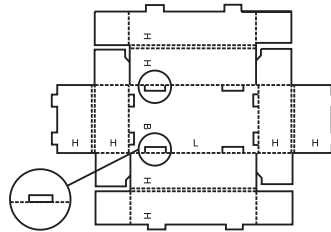

0426

M

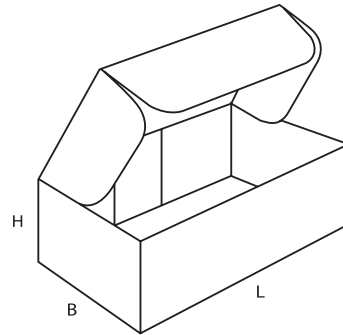
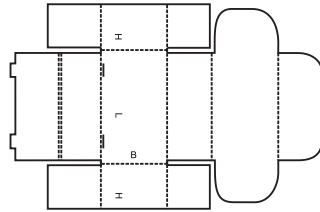

0427

M

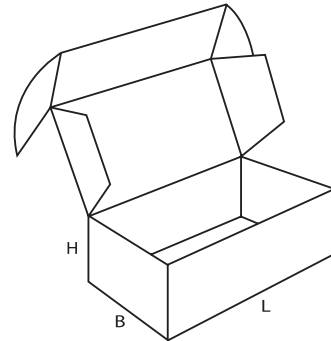
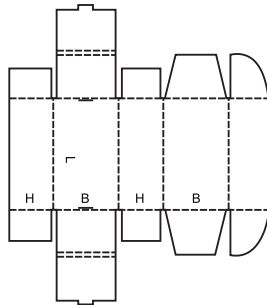

0428

M

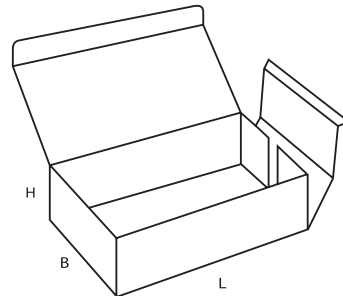
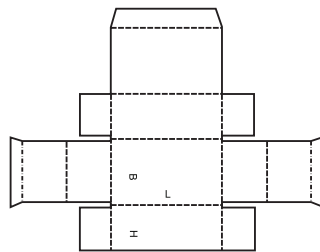

0429

M

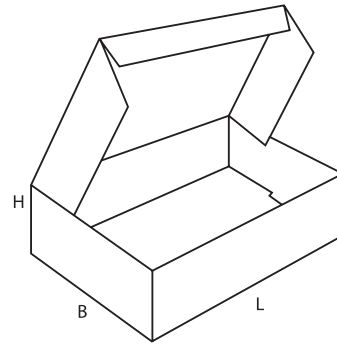
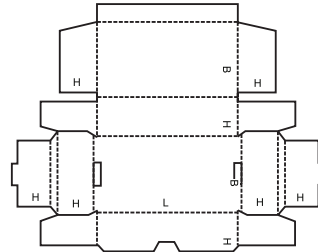

0430

M/A

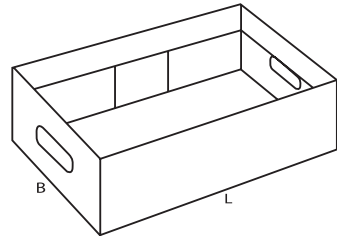
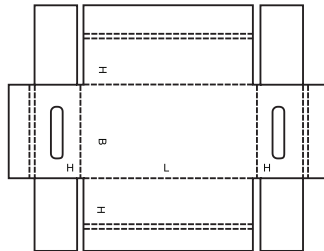

0431

M

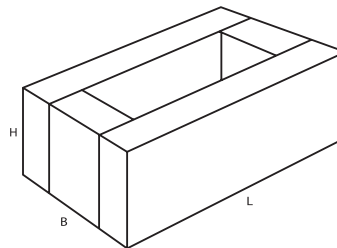
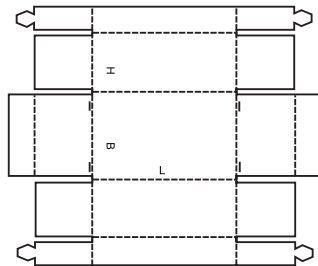

0432

M

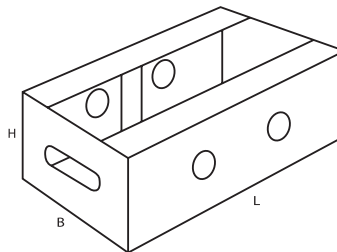
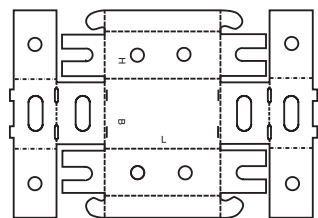

0433

M

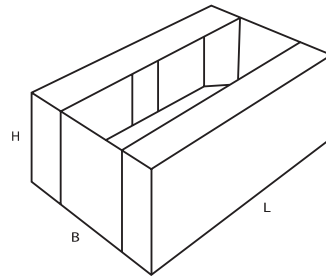
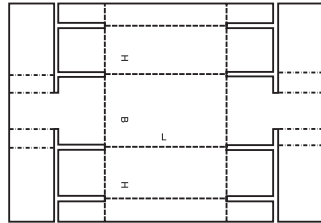

0434

M

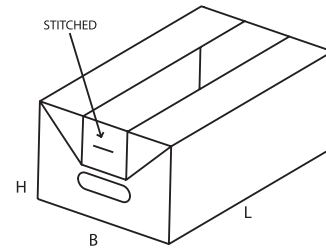
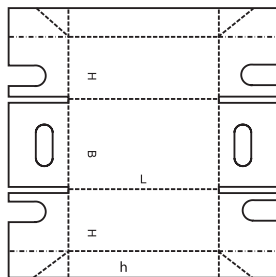

0435

M/A

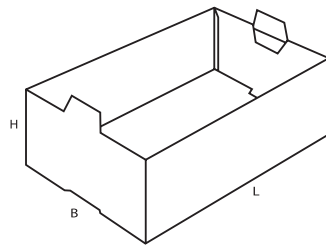
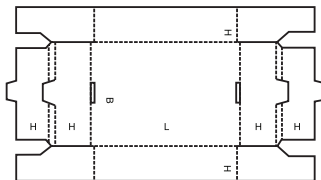

0436

M

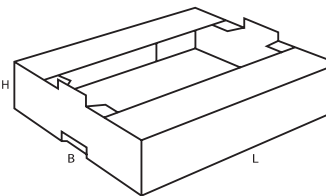
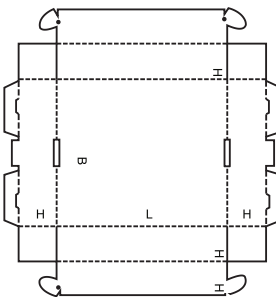

0437

M

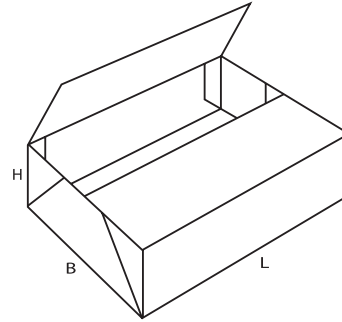
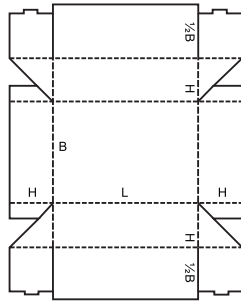

0440

A

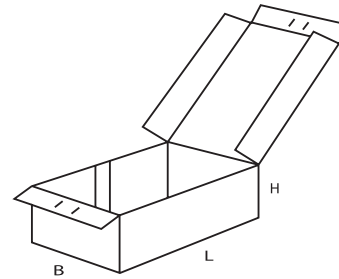
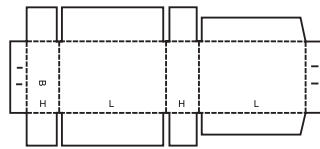

0441

A

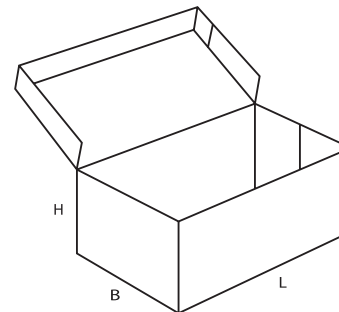
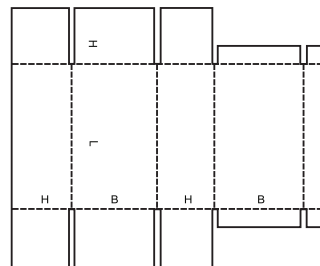

0442

M

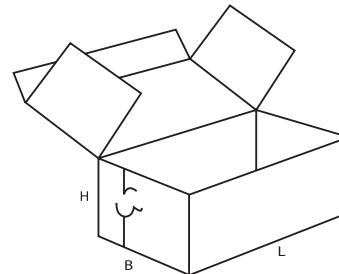
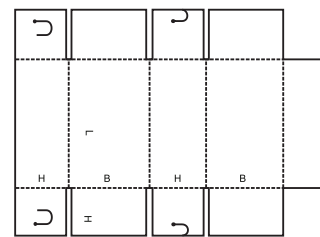

0443

M

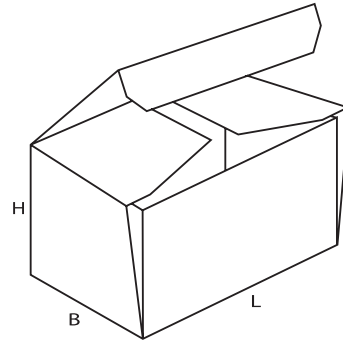
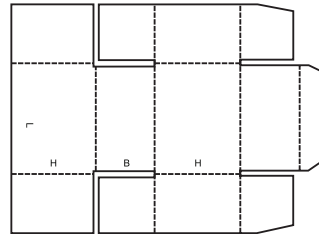

0444

M

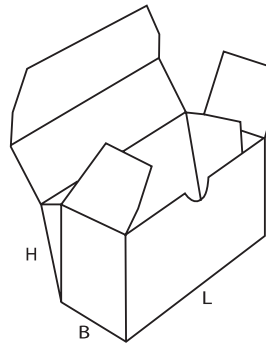
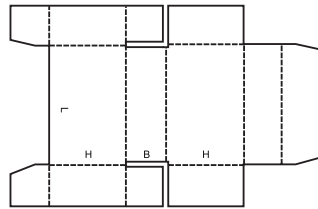

0445

M

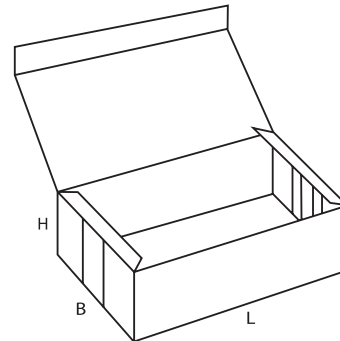
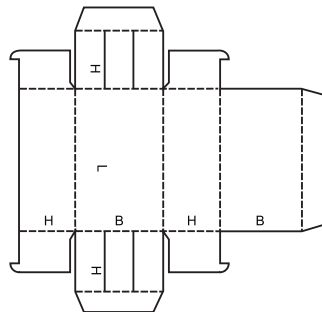

0446

A

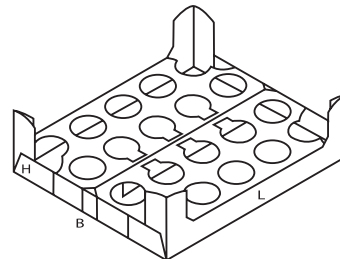
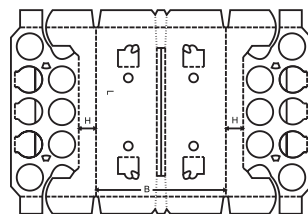

0447

M

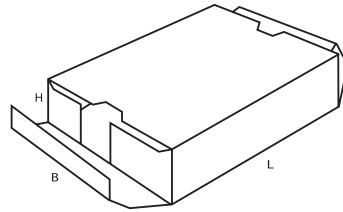
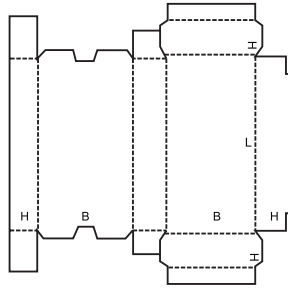

0448

M

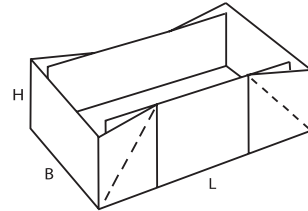
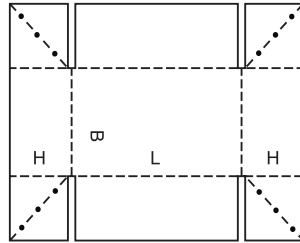

0449

M

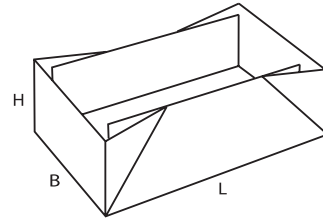
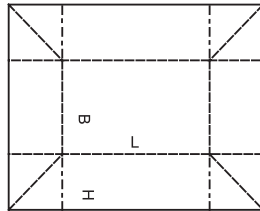

0450

M

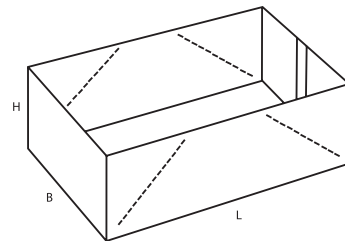
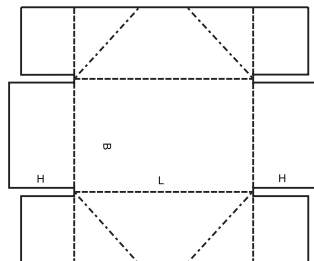

0451

M

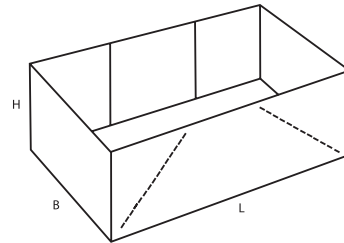
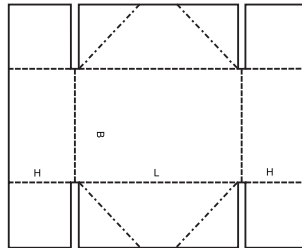

0452

A

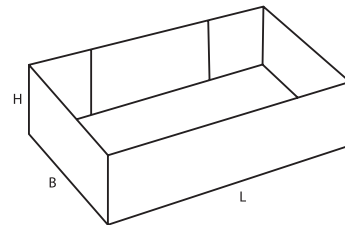
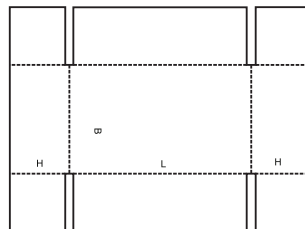

0453

A

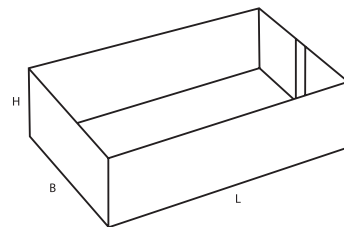
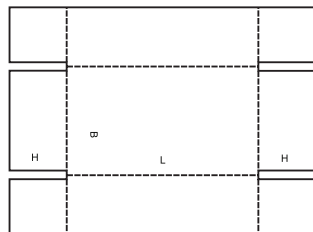

0454

M

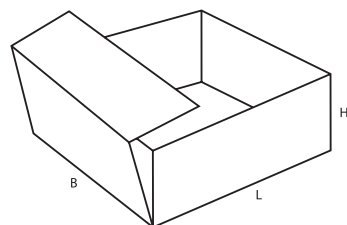
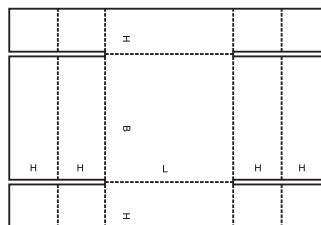

0455

M

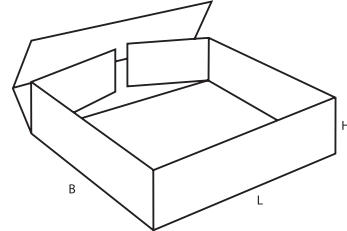
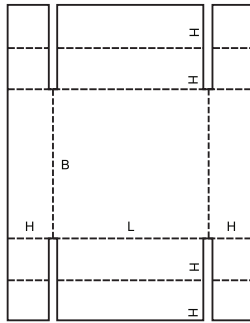

0456

M

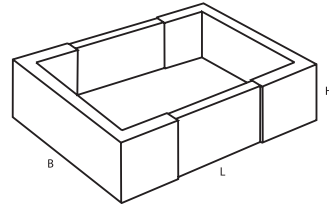
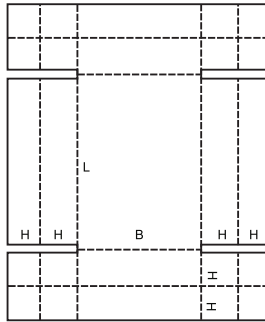

0457

M

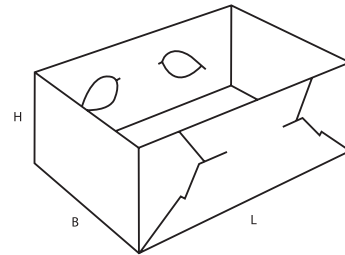
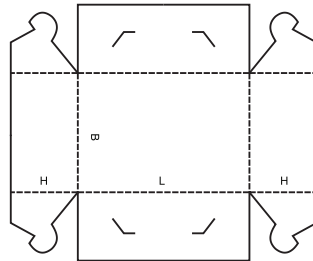

0458

M

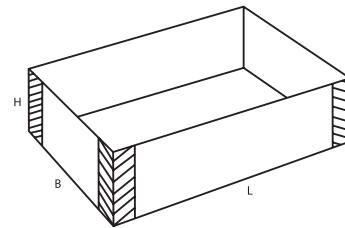
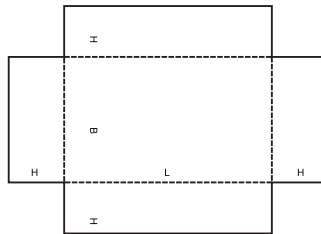

0459

A

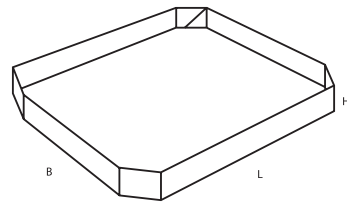
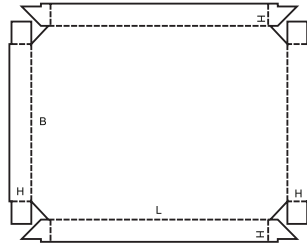

0460

A

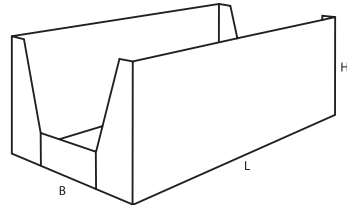
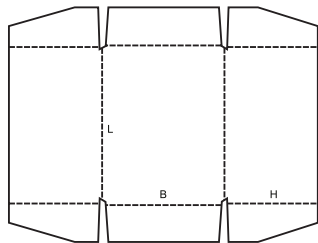

0470

M

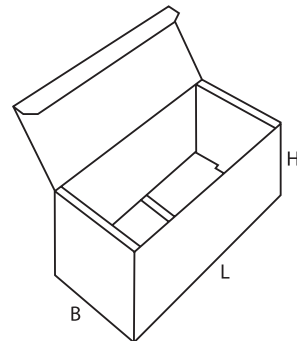
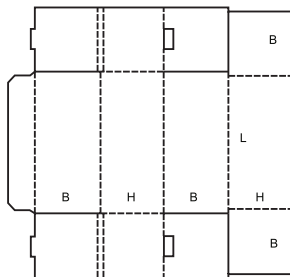

0471

M

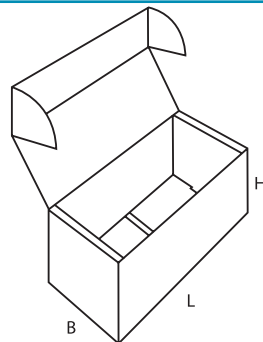
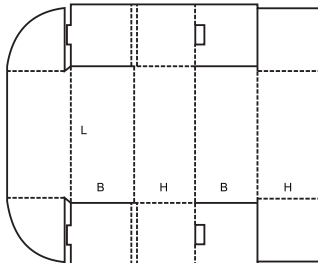

0472

M

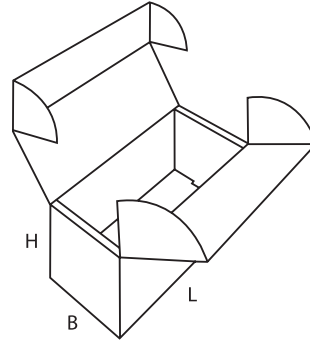
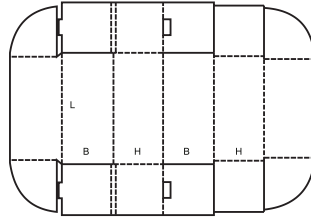

0473

M

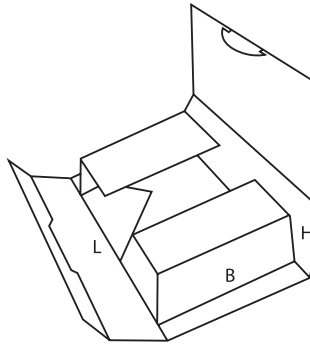
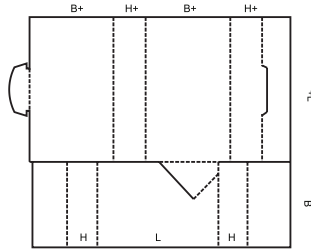

0500

▲ **Pudła wsuwane** składają się z większej ilości części (wewnętrznych oraz obwolut), które można w różnych kierunkach wsuwać jedno w drugie. Grupa ta obejmuje także obwoluty dla innych pudeł.

▲ **Slide-type boxes** consist of several pieces of liners and sleeves sliding in different directions into each other. This group also includes outside sleeves for other cases.

0501 M

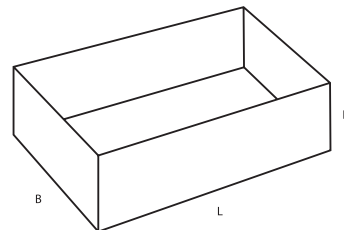

0502 M

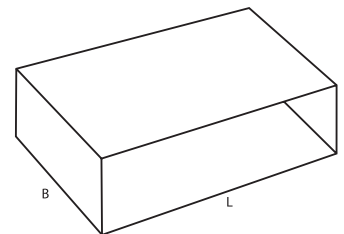
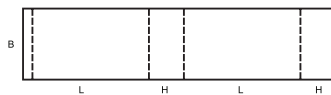

0503 M

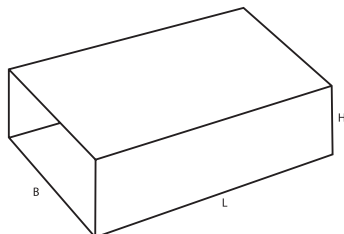
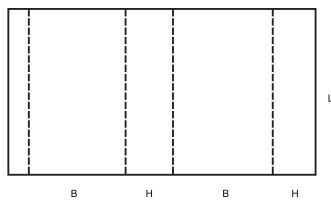

0504 M

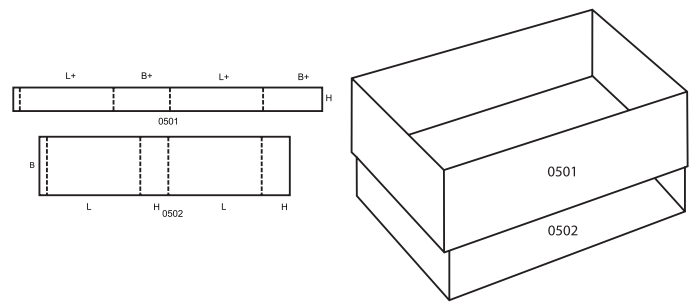

0505 M

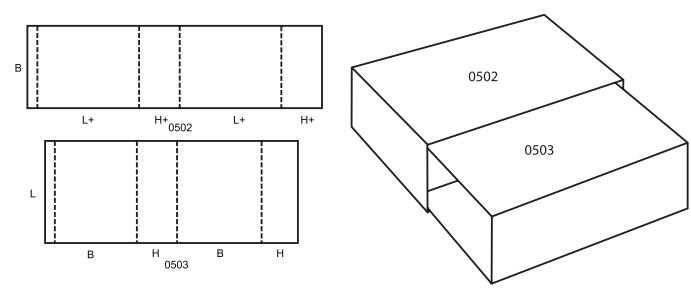

0507 M

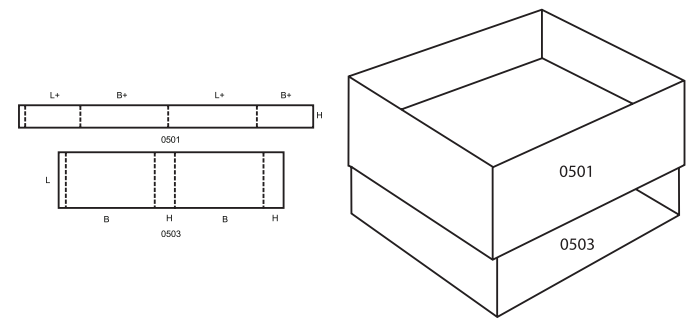

0509 M

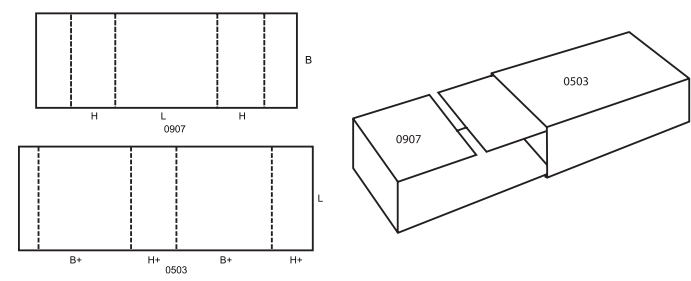

0510 M

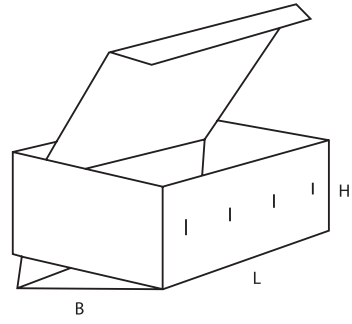
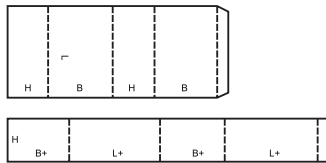

0511 M

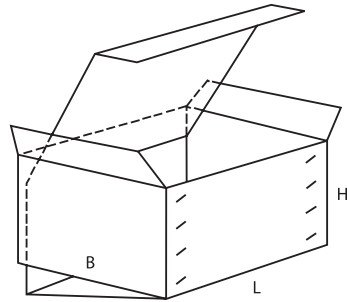
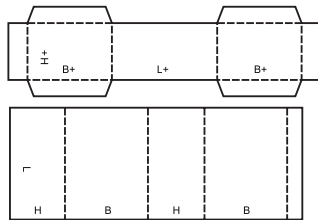

0512 M

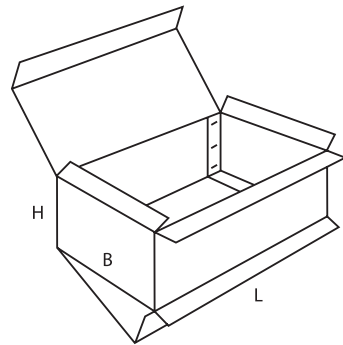
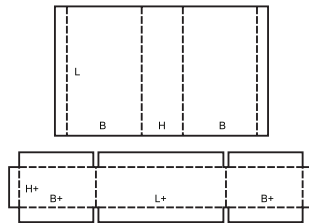

0600

▲ **Pudełka trwale łączone** składają się z dwóch oddzielnych części końcowych oraz korpusu i wymagają, przed ich użyciem, zszycia albo podobnej operacji.

▲ **Rigid-type boxes** consist of two separate end pieces and a body and require stitching or a similar operation before they can be used.

0601 A

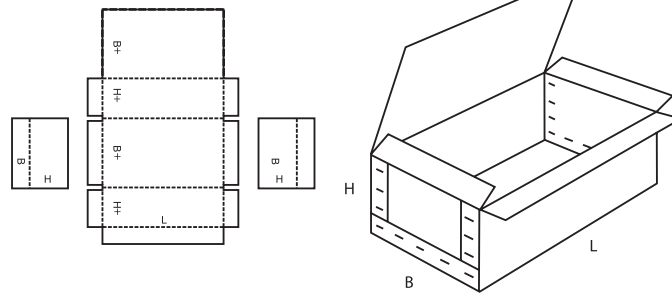

0602 A

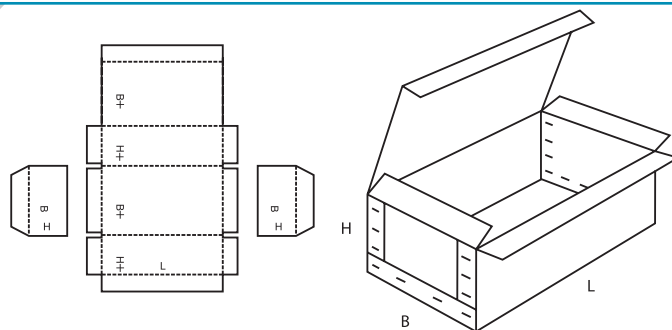

0605 A

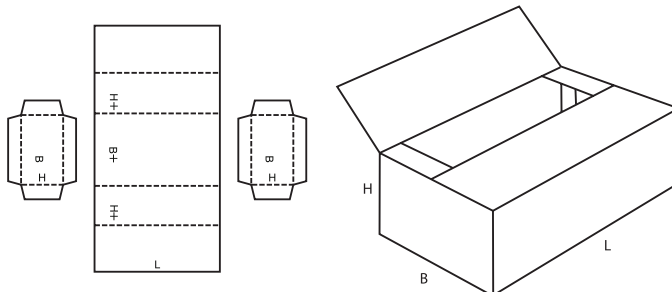

0606

A

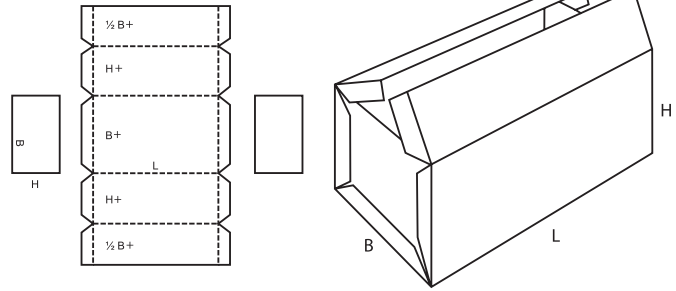

0607

A

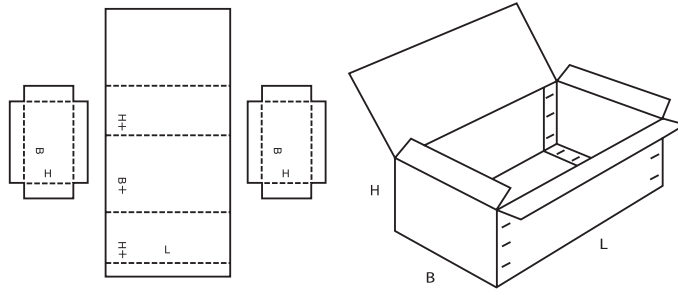

0608

A

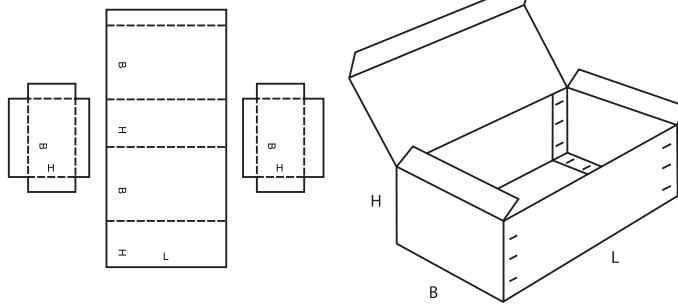

0610

M/A

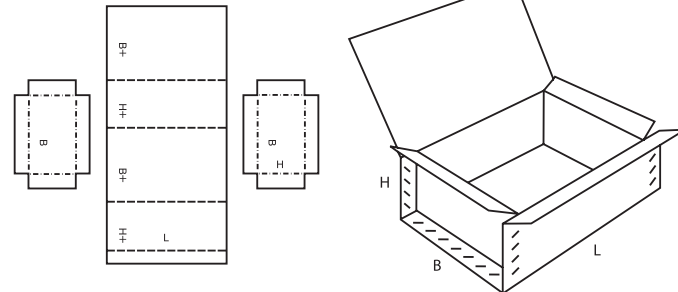

0615 M/A

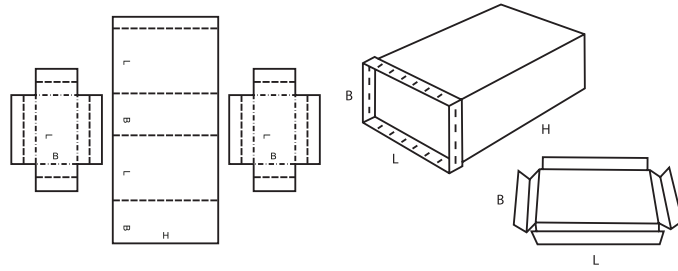

0616 M/A

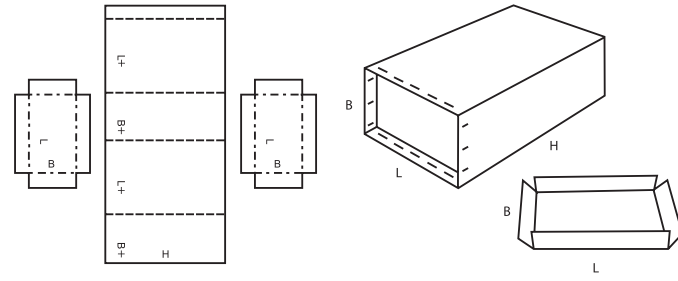

0620 A

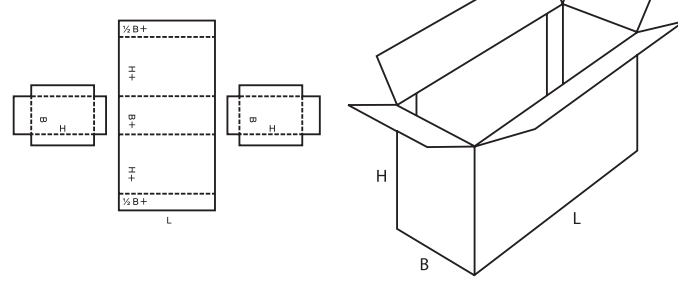

0621 M

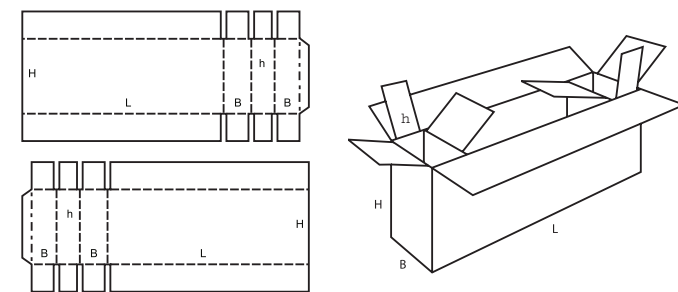

0700

▲ **Pudełka klejone jednoczęściowe** są to pudełka klejone, złożone zwykle z jednej części, dostarczane w stanie złożonym i gotowe do użycia po ich prostym rozłożeniu.

▲ **Ready-glued** cases consist of basically one piece, are shipped flat and ready to use by simple setting up.

0700 M

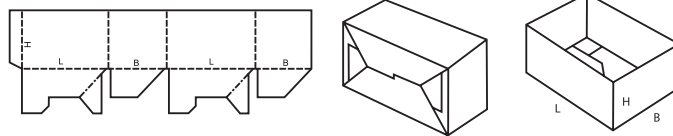

0701 M

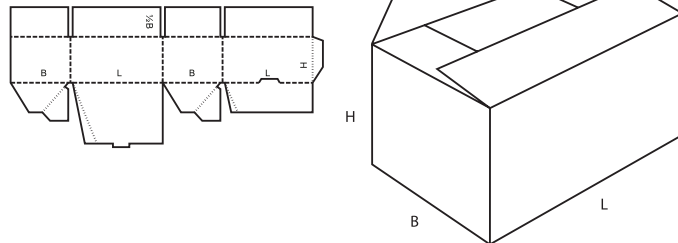

0703 M

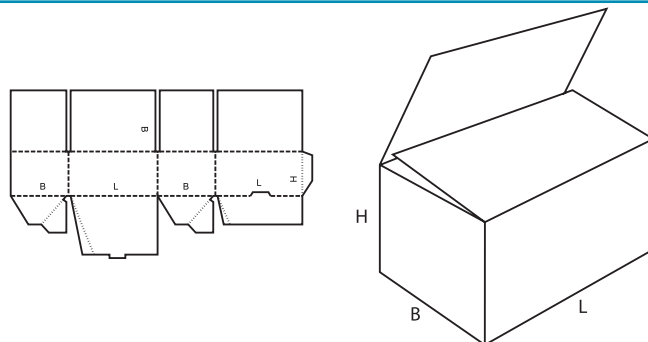

0711 M

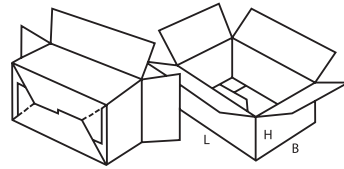
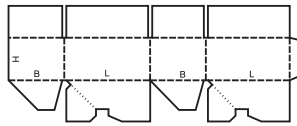

0712 M

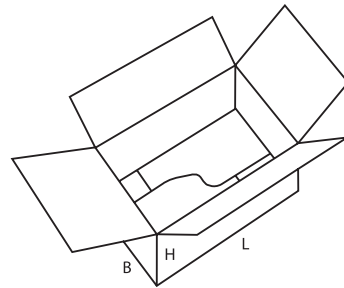
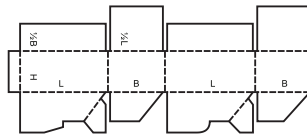

0713 M

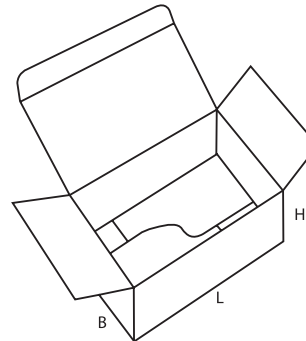
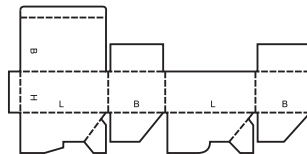

0714 M

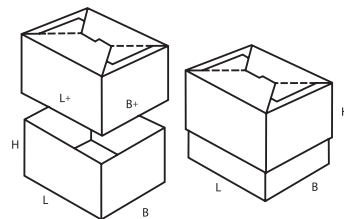
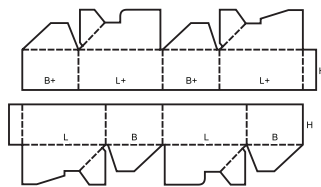

0715

M

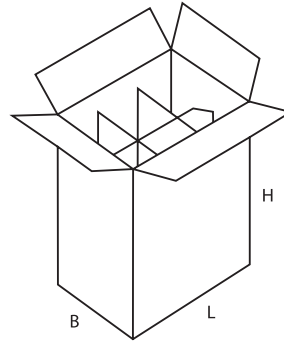
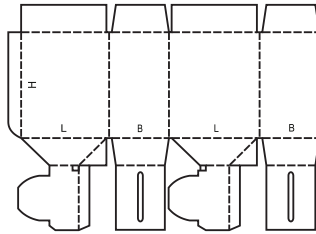

0716

M

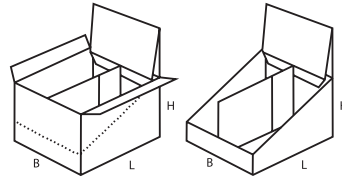
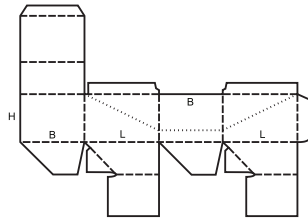

0717

M

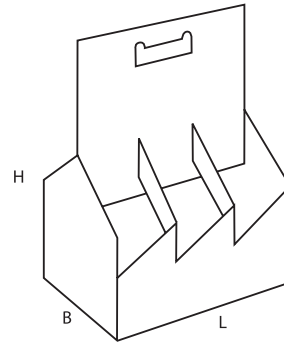
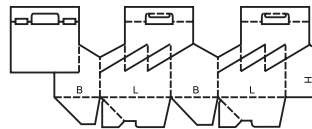

0718

M

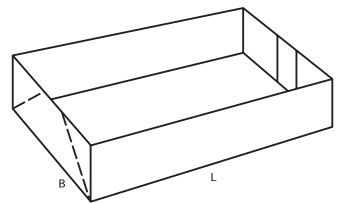
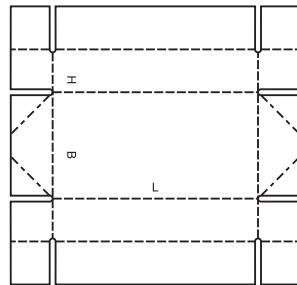

$B \geq 2H$

0747 M

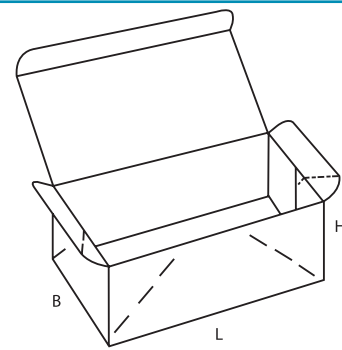
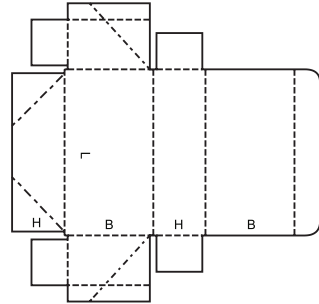

0748 M

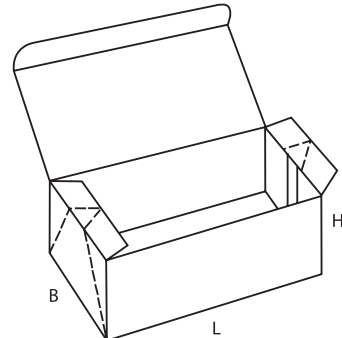
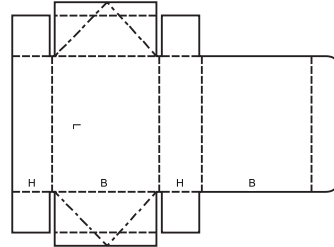

0751 M

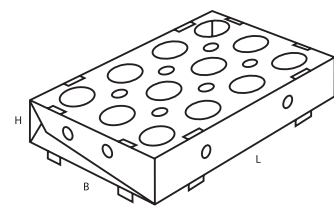
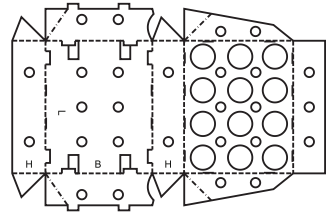

0752 M/A

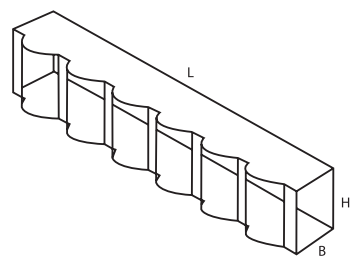
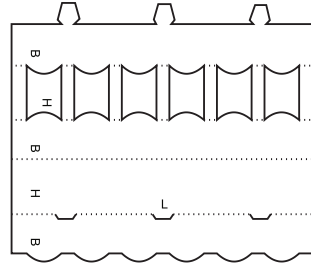

0759

M

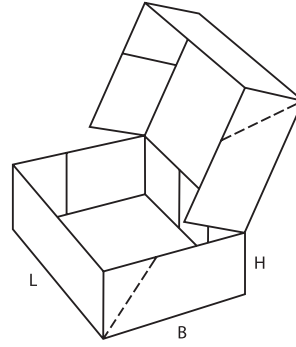
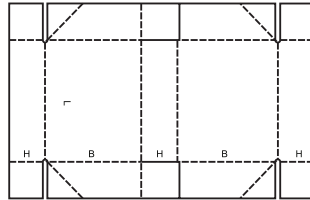

0761

M

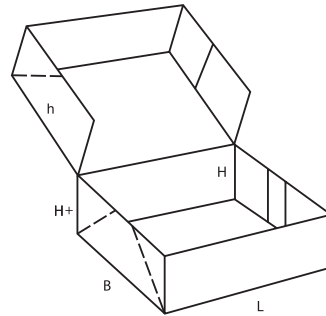
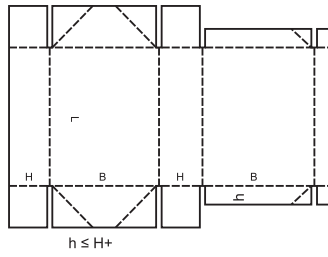

0770

M

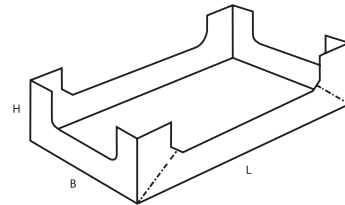
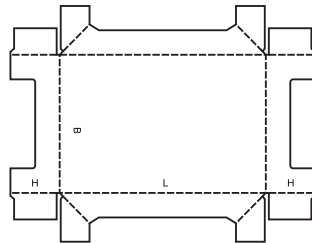

0771

M

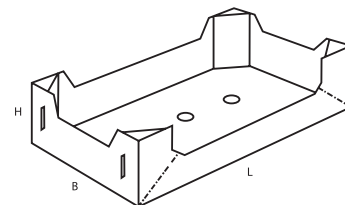
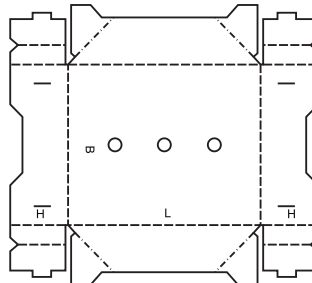

0772

M

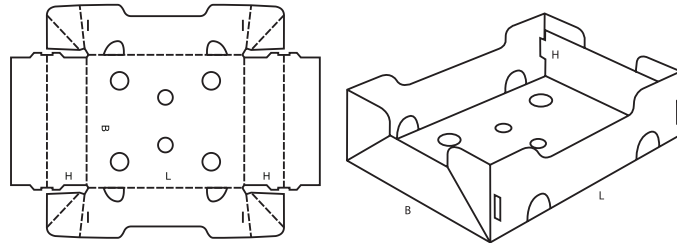

0773

M

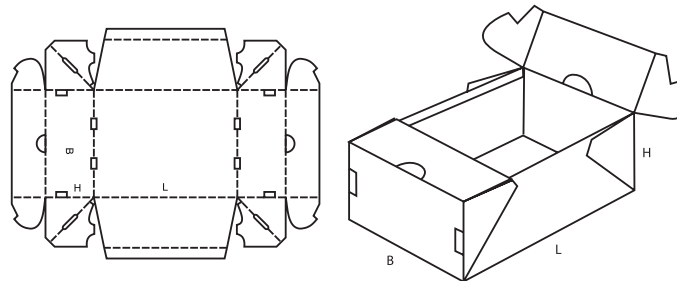

0774

M

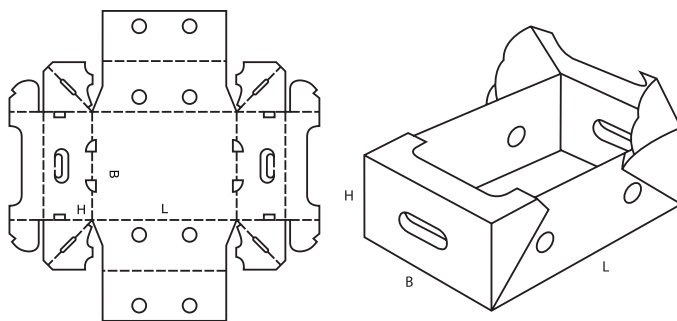

0900

▲ **Wyposażenie wewnętrzne** pudeł, takie jak wkładki, przekładki, kratownice, wkładki wypełniające itd., stanowiące elementy związane z konstrukcją pudła albo osobne. Wskazana ilość elementów jest dowolna i może być, stosownie od wymagań, zwiększana lub zmniejszana.

▲ **Interior fitments** such as inside liners, pads, partitions, dividers etc., whether tied to Case Design or as singular items. Any shown number of panels is arbitrary and may be increased or decreased as required.

0900 M

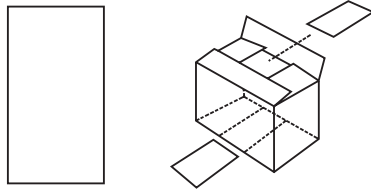

0901 M

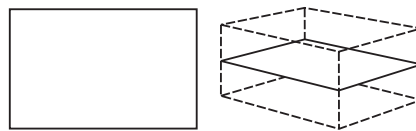

0902 M

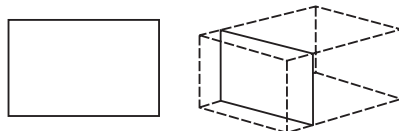

0903 M

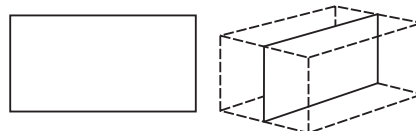

0904 M

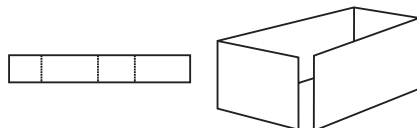

0905 M

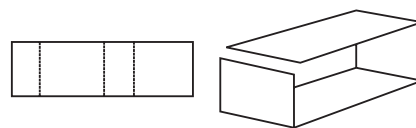

0906 M

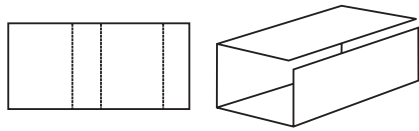

0907 M

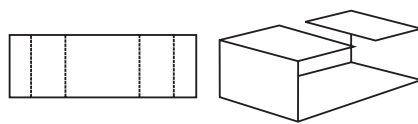

0908 M

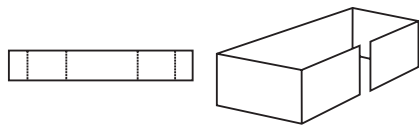

0909 M

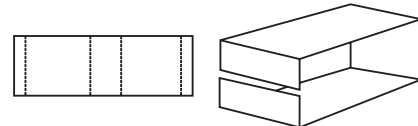

0910 A

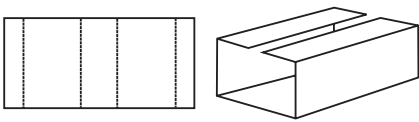

0911 A

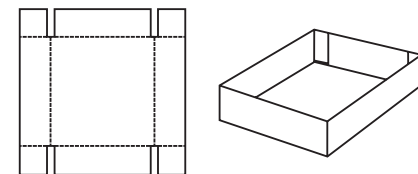

0913 M

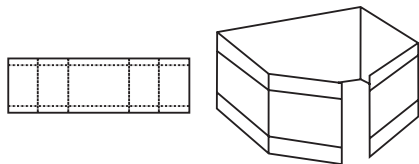

0914 M

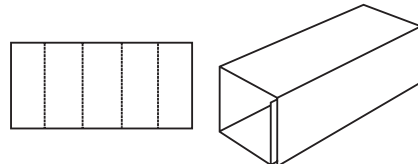

0920 M

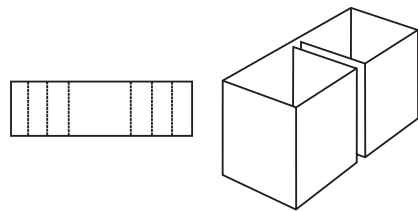

0921 M

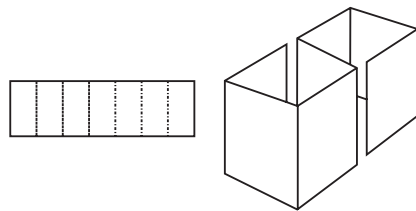

0929 M

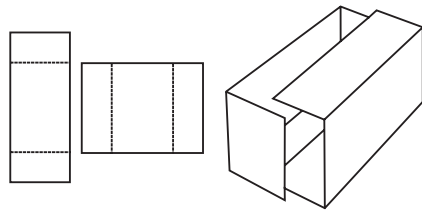

0930 M

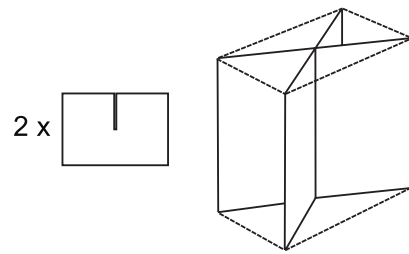

0931 M

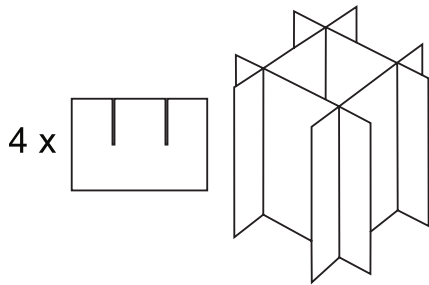

0932 M

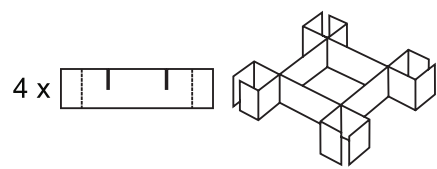

0933 M

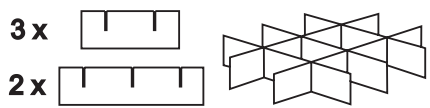

0934 M

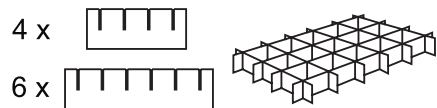

0935

M

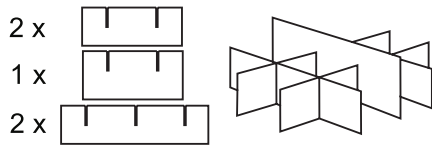

0940

M

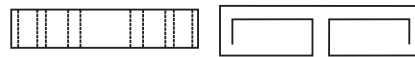

0941

M

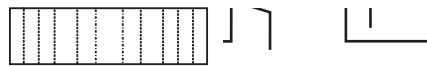

0942

M

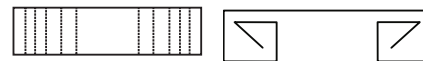

0943

M



0944

M



0945

M



0946

M



0947

M



0948

M



0949

M

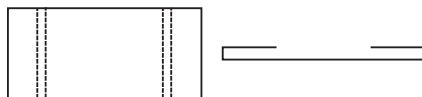

0950

M

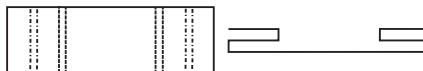

0951

M

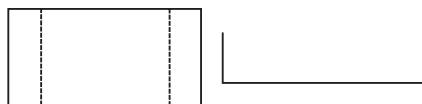

0965

M

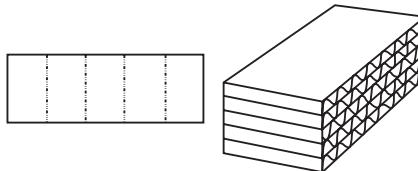

0966

M

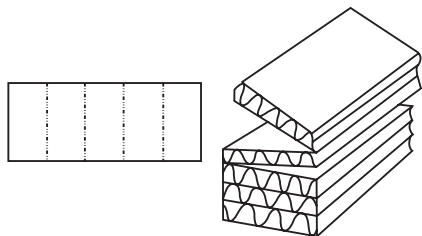

0967

M

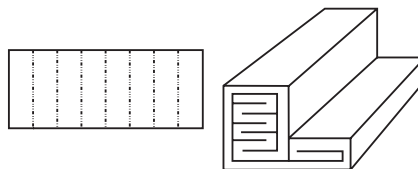

0970

M

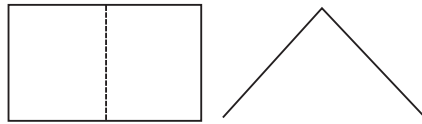

0971

M

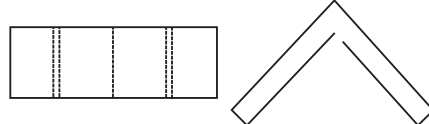

0972

M

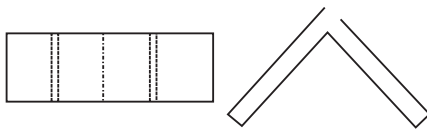

0973

M

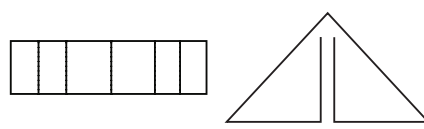

0974

M

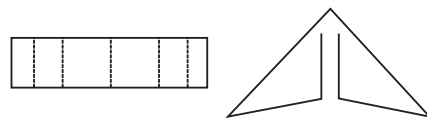

0975

M

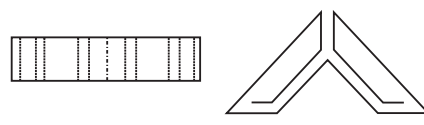

0976

M

